

**BLANKING DIMENSIONS FOR 8 5/8" x 32lb/ft (219.08mm x 8.94mm WT)**

**HSC COUPLING (REGULAR OD)**

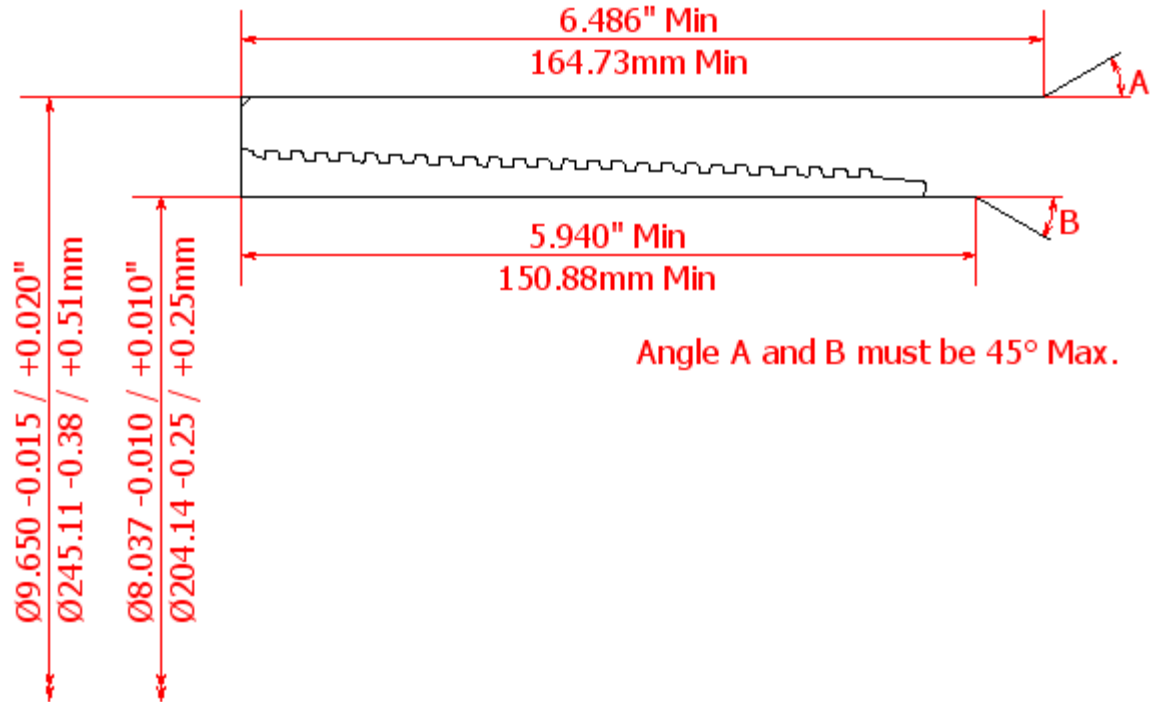

**HSC COUPLING (SPECIAL CLEARANCE OD)**

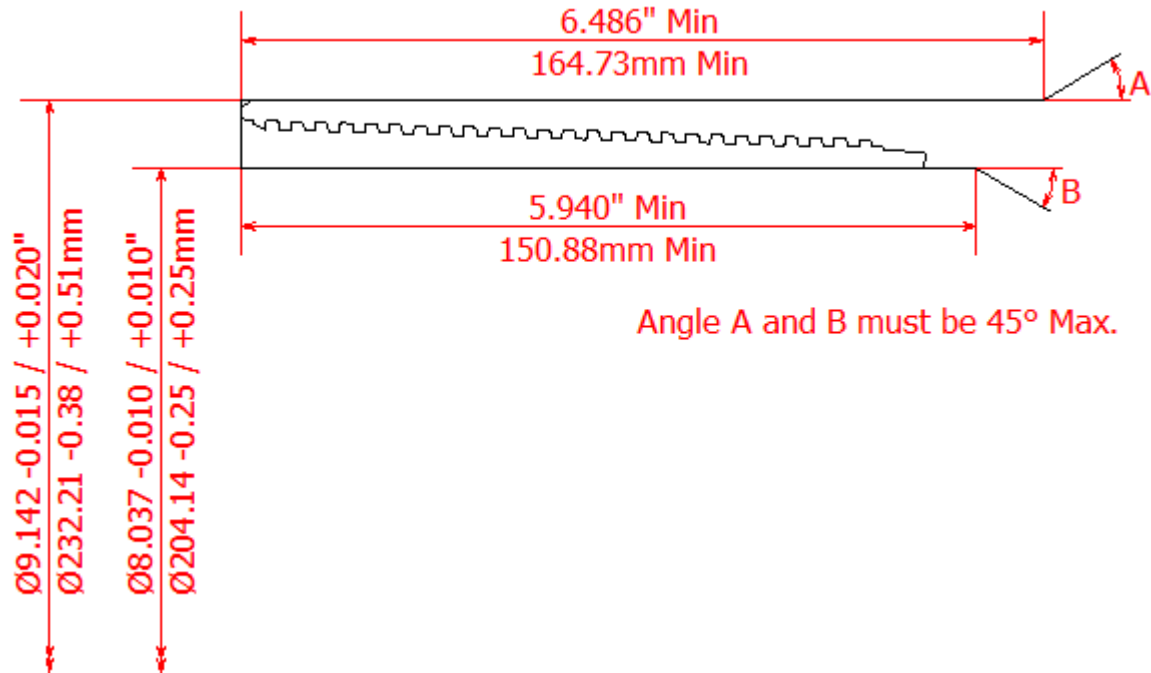

**HSC PIN**

