

**BLANKING DIMENSIONS FOR 2 3/8" x 5.8lb/ft (60.32mm x 6.45mm WT)**

**HSC COUPLING (REGULAR OD)**

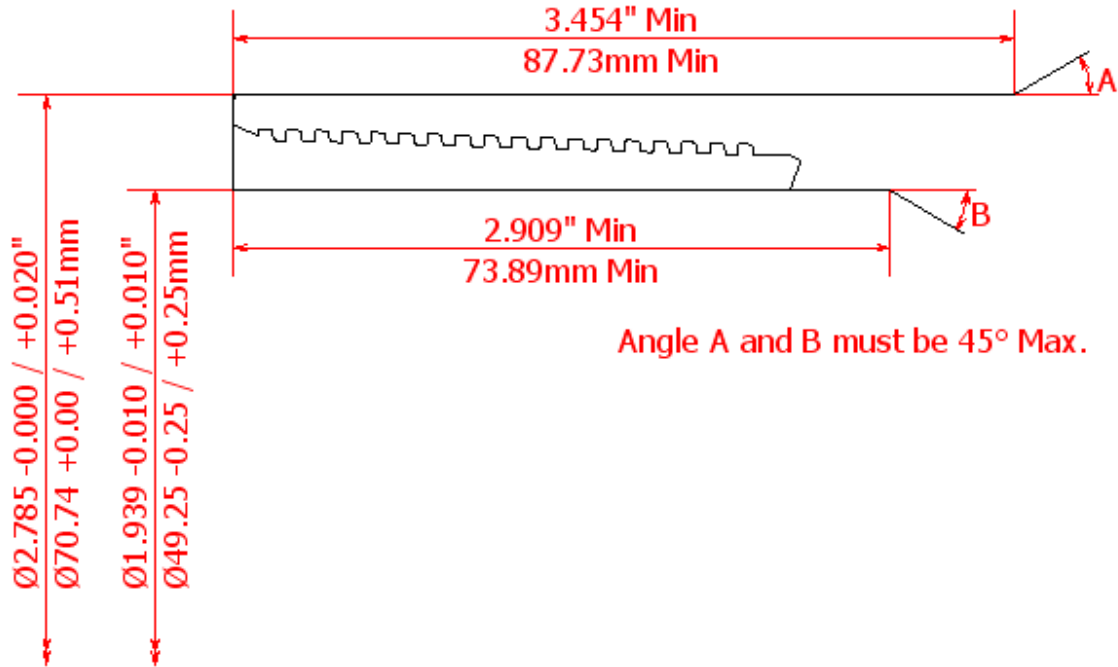

**HSC COUPLING (SPECIAL CLEARANCE OD)**

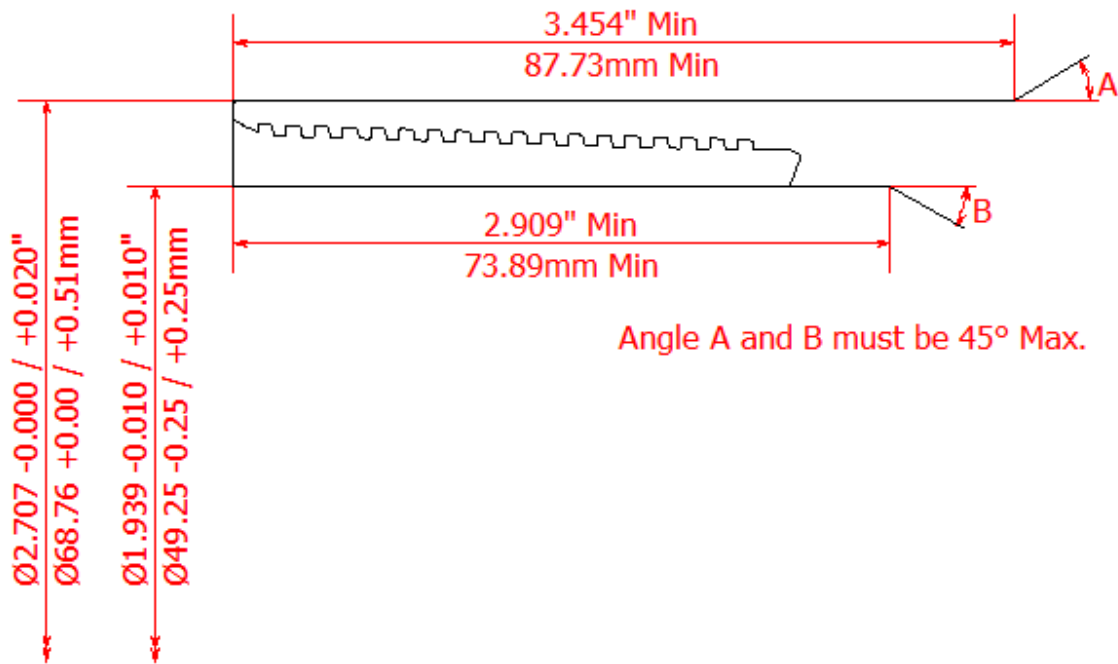

**HSC PIN**

