

**BLANKING DIMENSIONS FOR 3 1/2" x 10.2lb/ft (88.9mm x 7.34mm WT)**

**HSC COUPLING (REGULAR OD)**

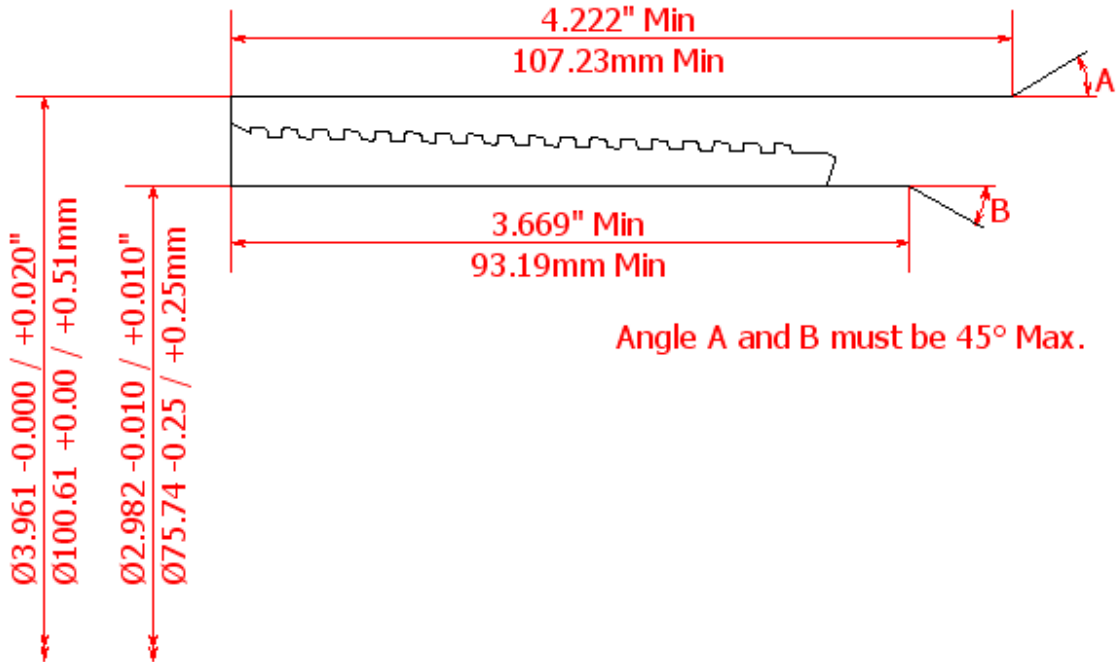

**HSC COUPLING (SPECIAL CLEARANCE OD)**

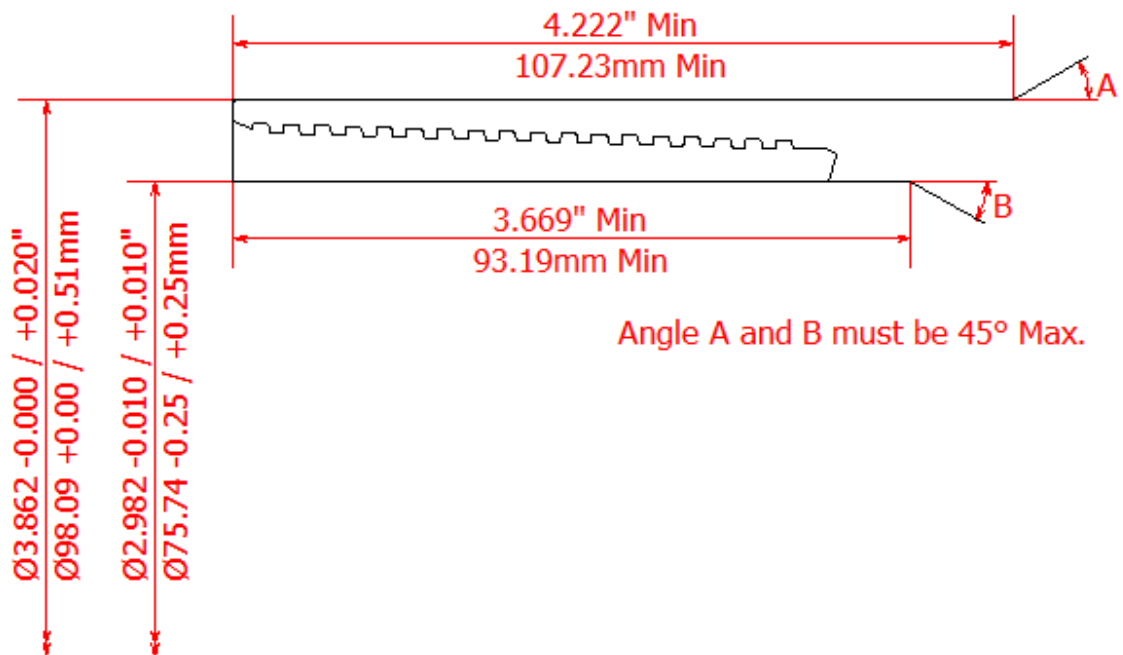

**HSC PIN**

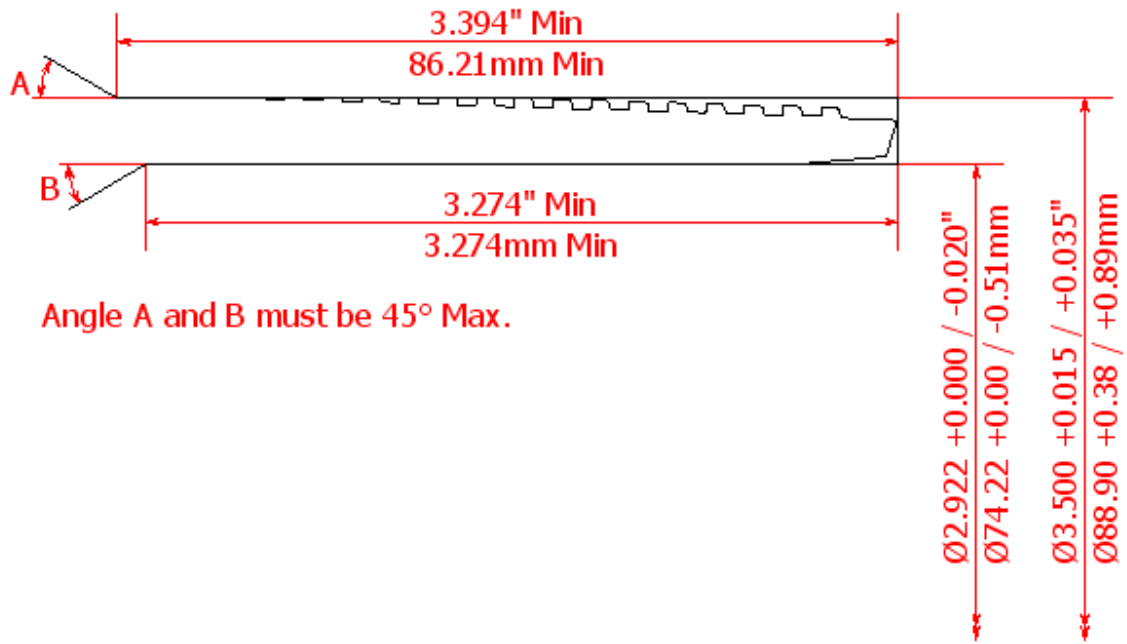

Angle A and B must be 45° Max.