

BLANKING DIMENSIONS FOR 3 1/2" x 12.7lb/ft (88.9mm x 9.52mm WT)

HSC COUPLING (REGULAR OD)

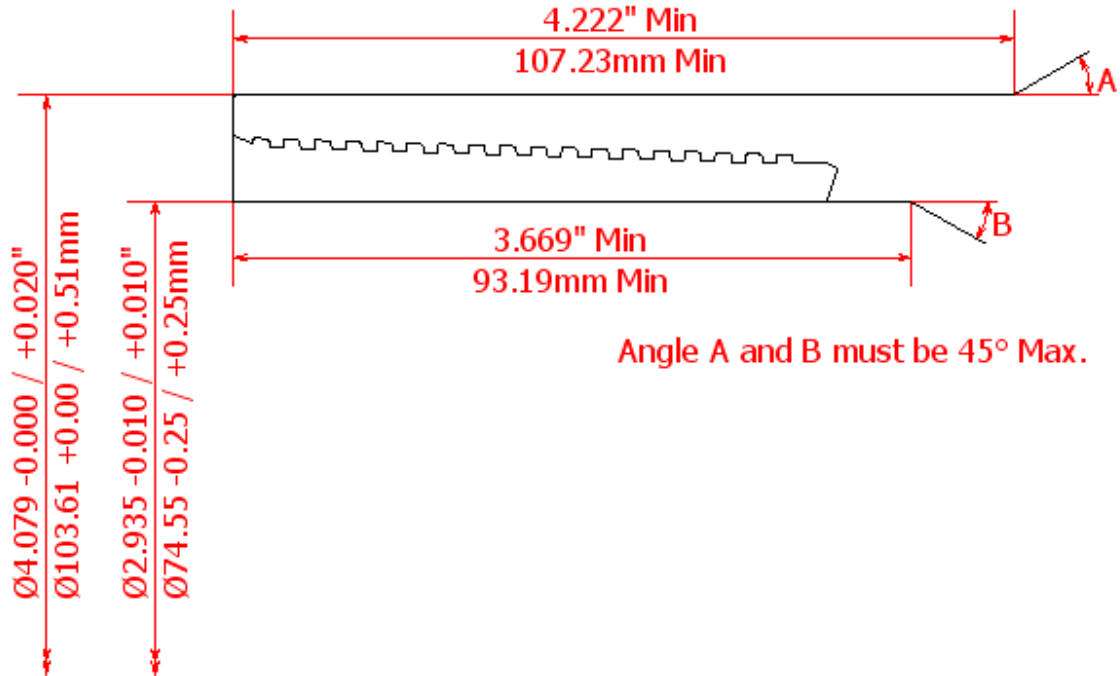

HSC COUPLING (SPECIAL CLEARANCE OD)

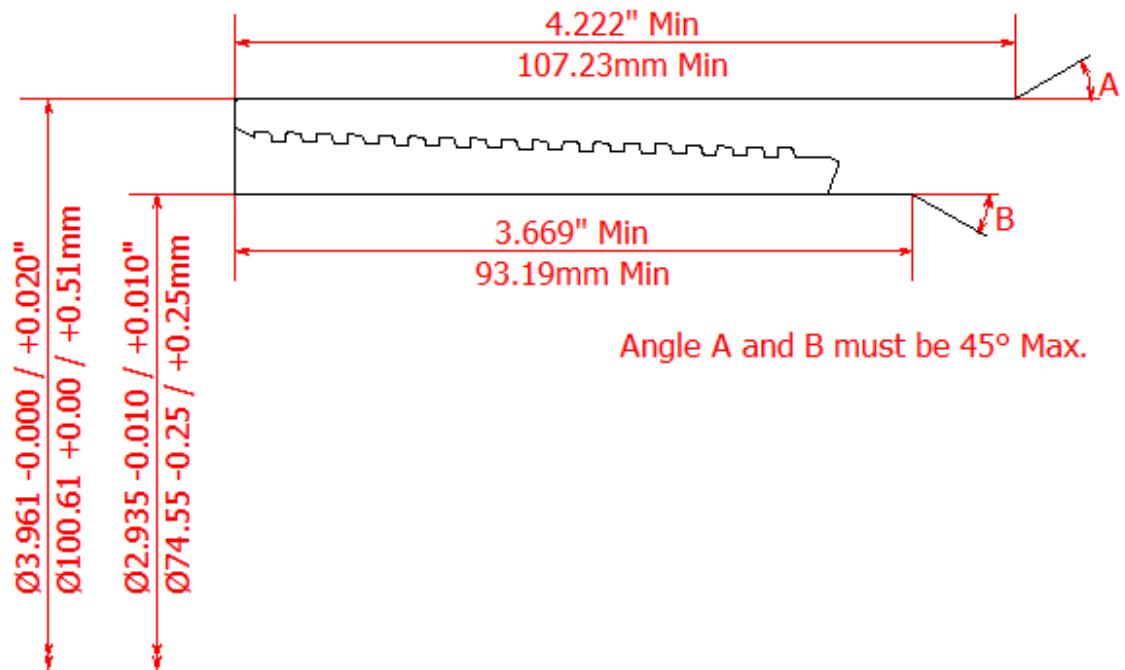

HSC PIN

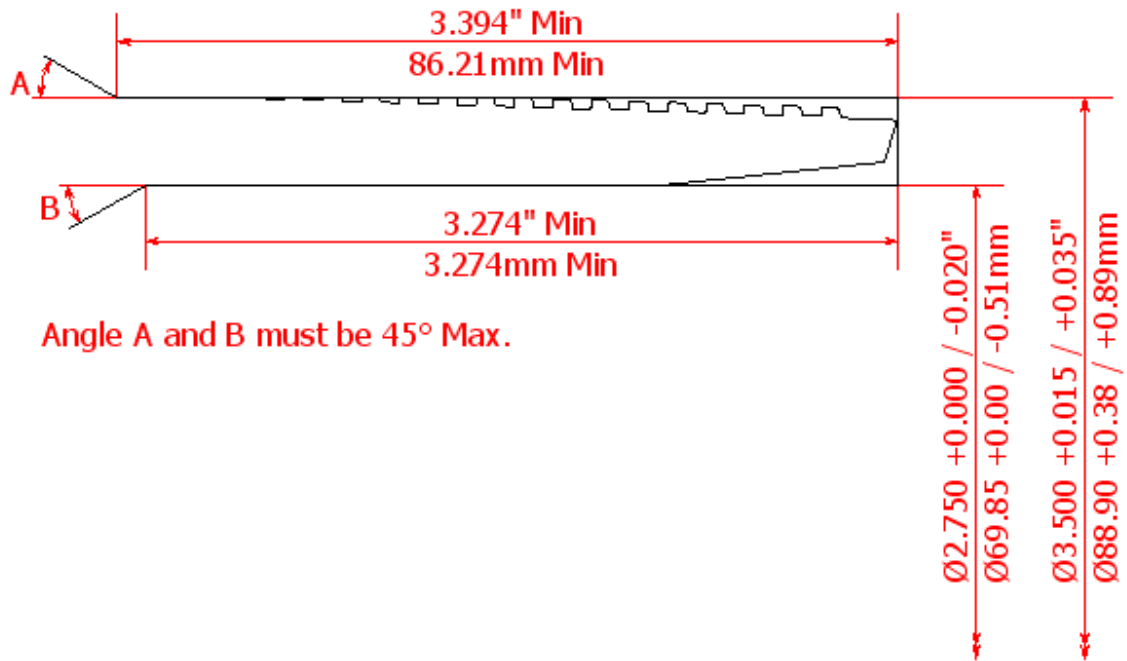

Angle A and B must be 45° Max.