

BLANKING DIMENSIONS FOR 4 1/2" x 13.5lb/ft (114.3mm x 7.37mm WT)

HSC COUPLING (REGULAR OD)

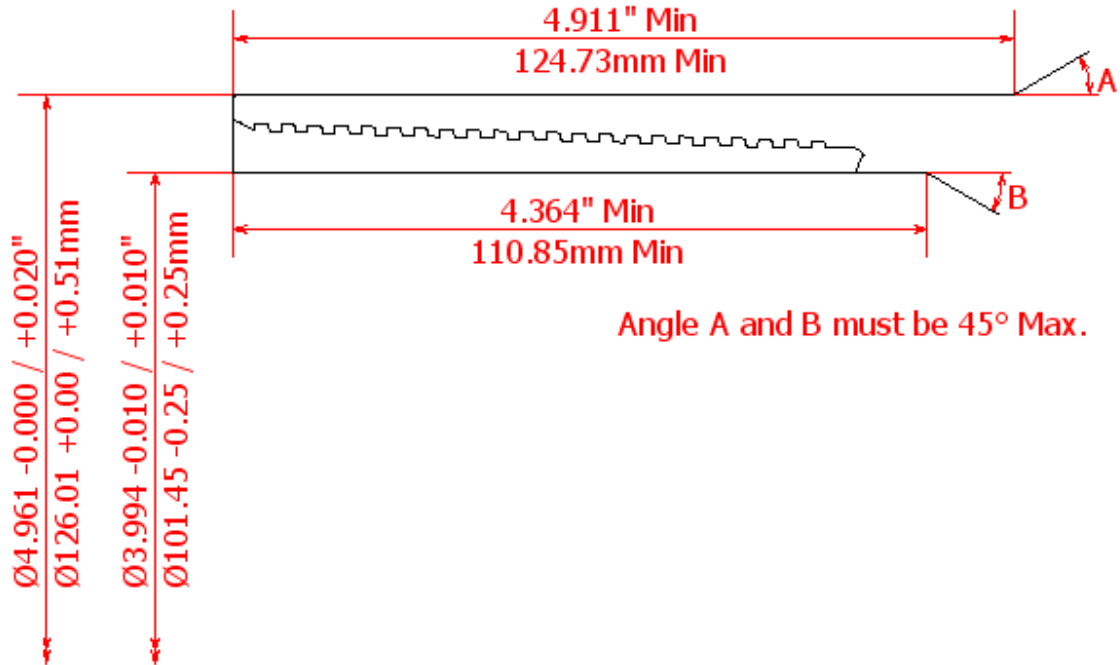

HSC COUPLING (SPECIAL CLEARANCE OD)

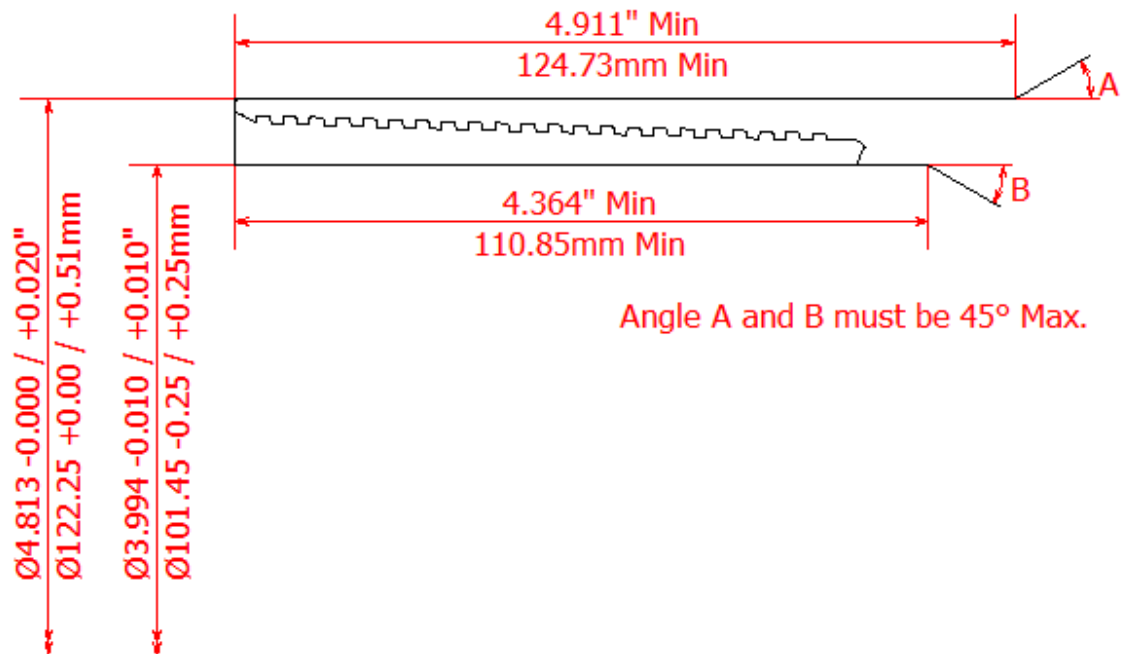

HSC PIN

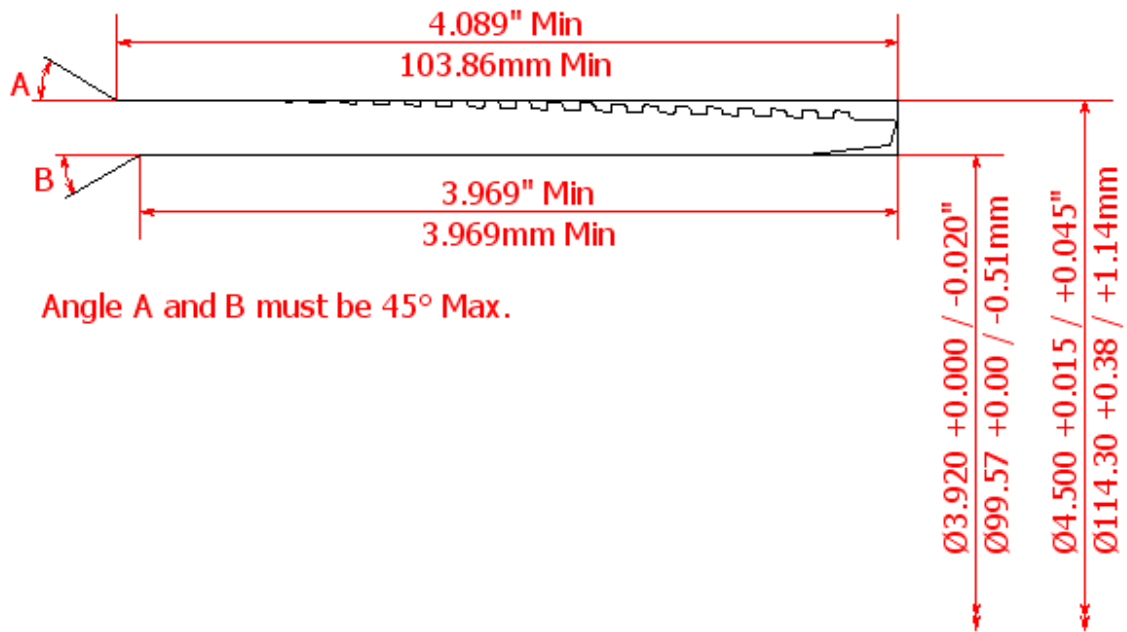

Angle A and B must be 45° Max.