

**BLANKING DIMENSIONS FOR 4" x 9.5lb/ft (101.6mm x 5.74mm WT)**

**HSC COUPLING (REGULAR OD)**

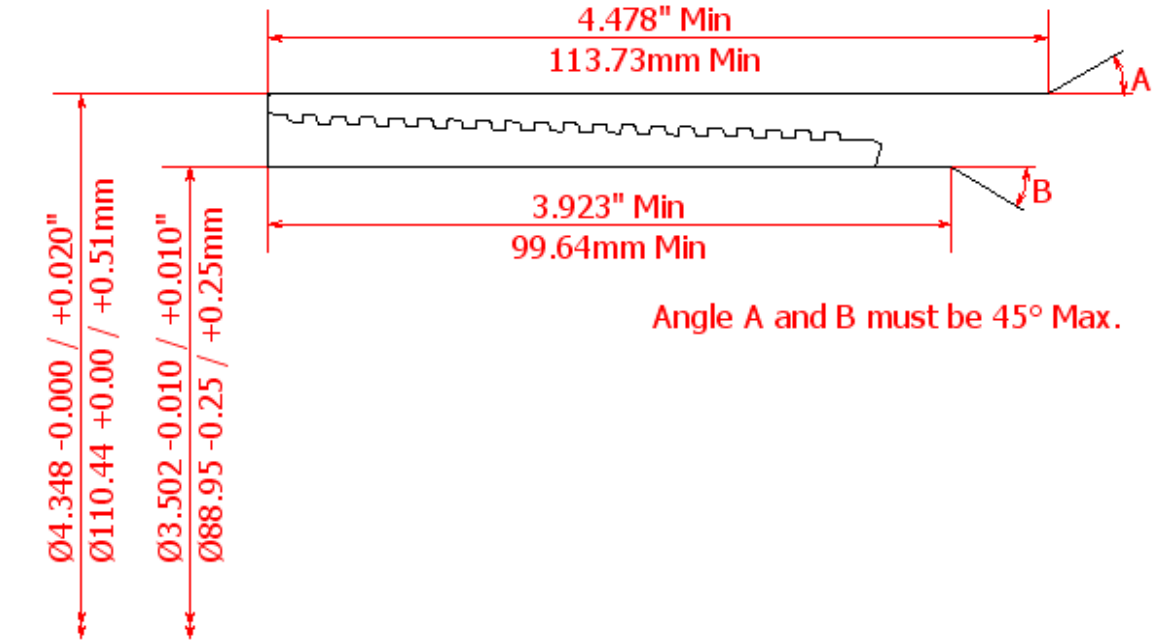

**HSC COUPLING (SPECIAL CLEARANCE OD)**

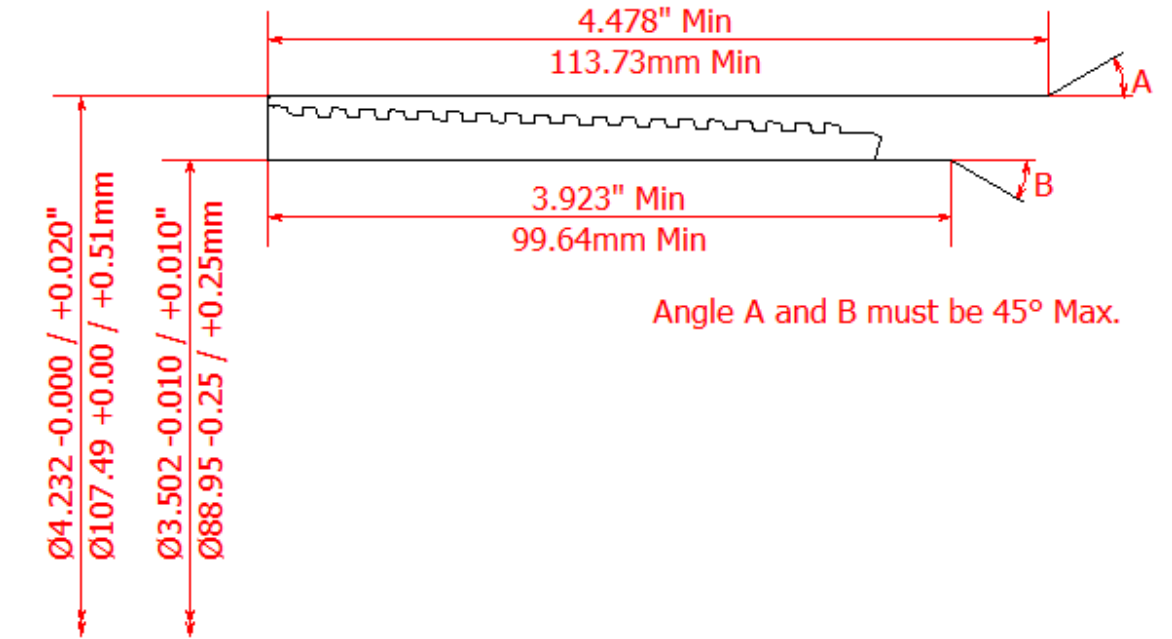

**HSC PIN**

