

**BLANKING DIMENSIONS FOR 10 3/4" x 40.5lb/ft (273.05mm x 8.89mm WT)**

**HSC COUPLING (REGULAR OD)**

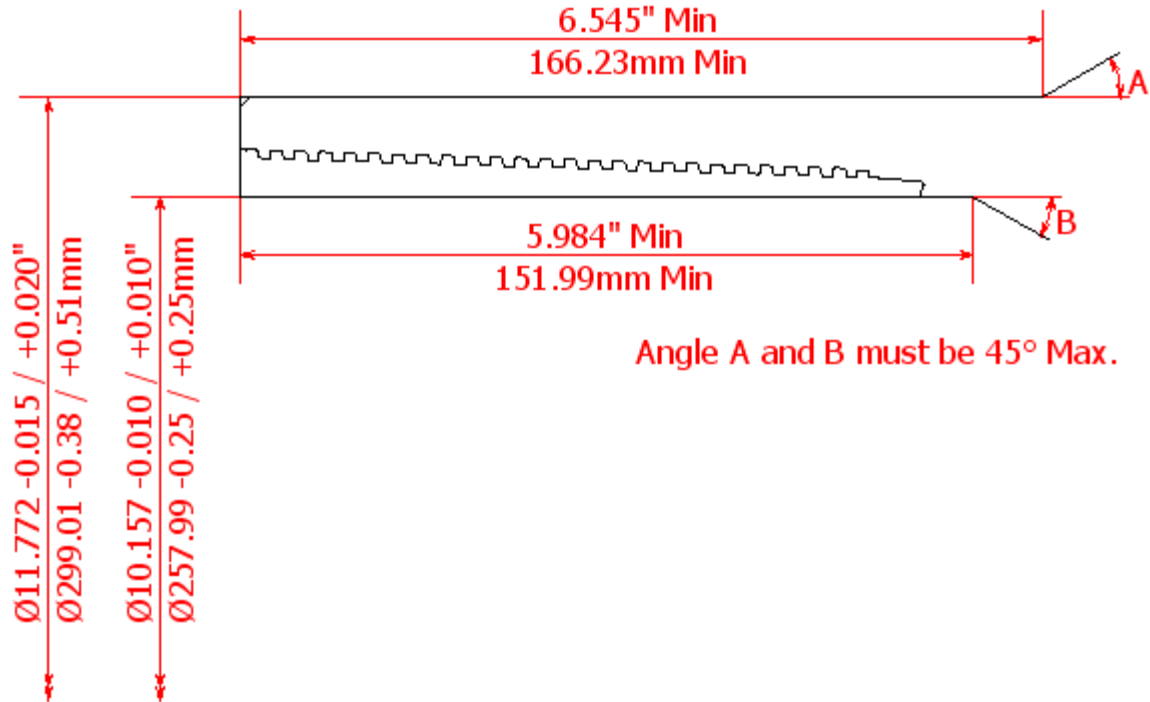

**HSC COUPLING (SPECIAL CLEARANCE OD)**

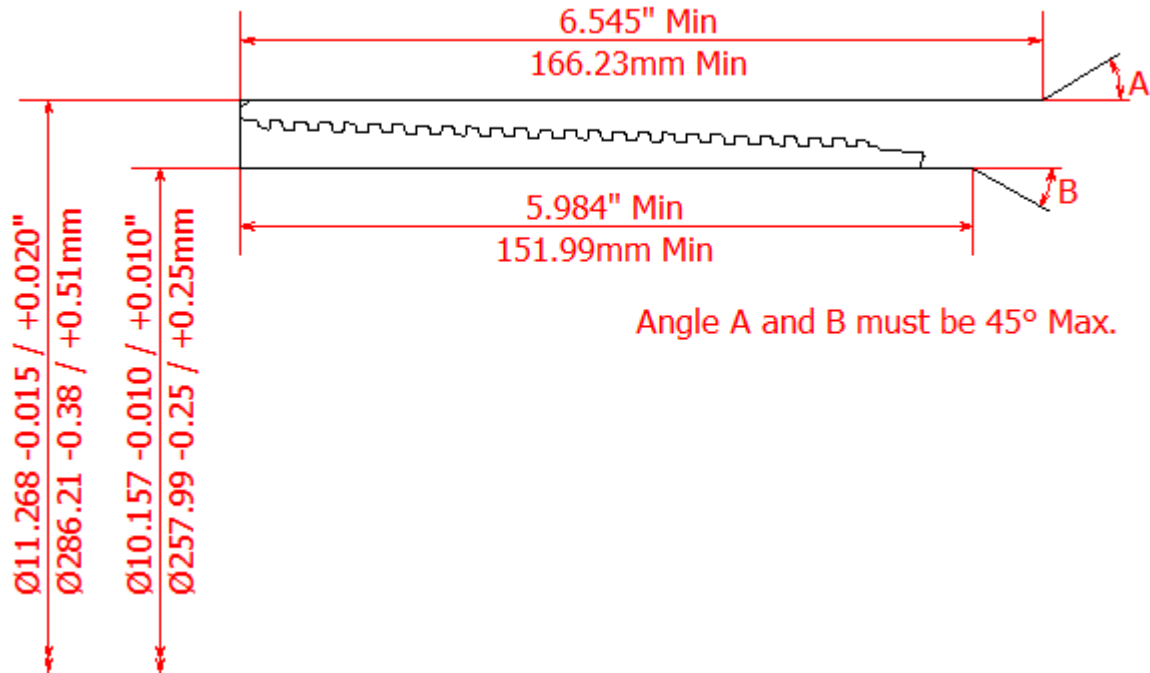

**HSC PIN**

