

**BLANKING DIMENSIONS FOR 11 3/4" x 54lb/ft (298.45mm x 11.05mm WT)**

**HSC COUPLING (REGULAR OD)**

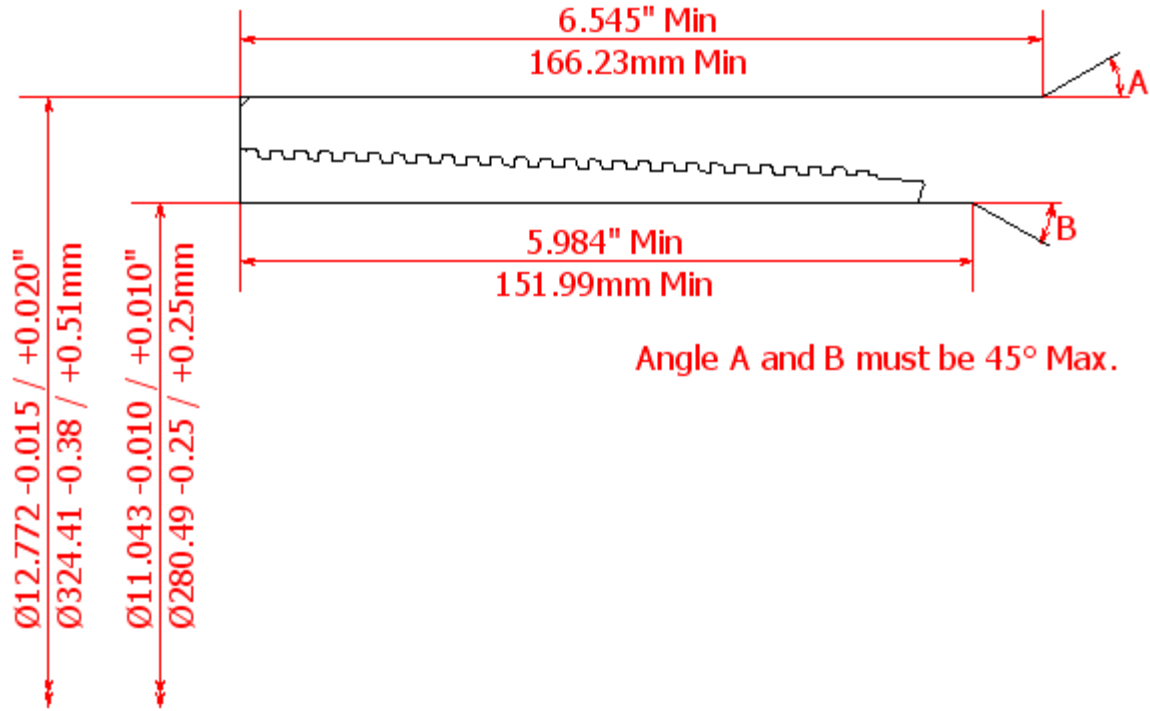

**HSC COUPLING (SPECIAL CLEARANCE OD)**

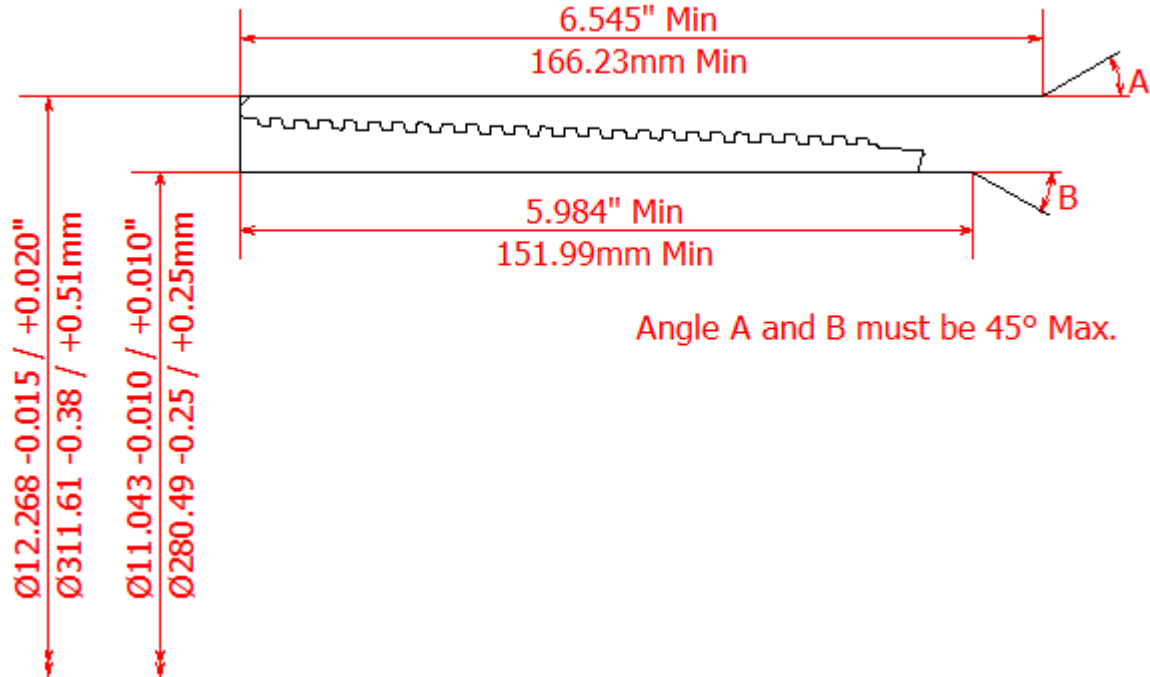

**HSC PIN**

