

**BLANKING DIMENSIONS FOR 5 1/2" x 15.5lb/ft (139.7mm x 6.98mm WT)**

**HSC COUPLING (REGULAR OD)**

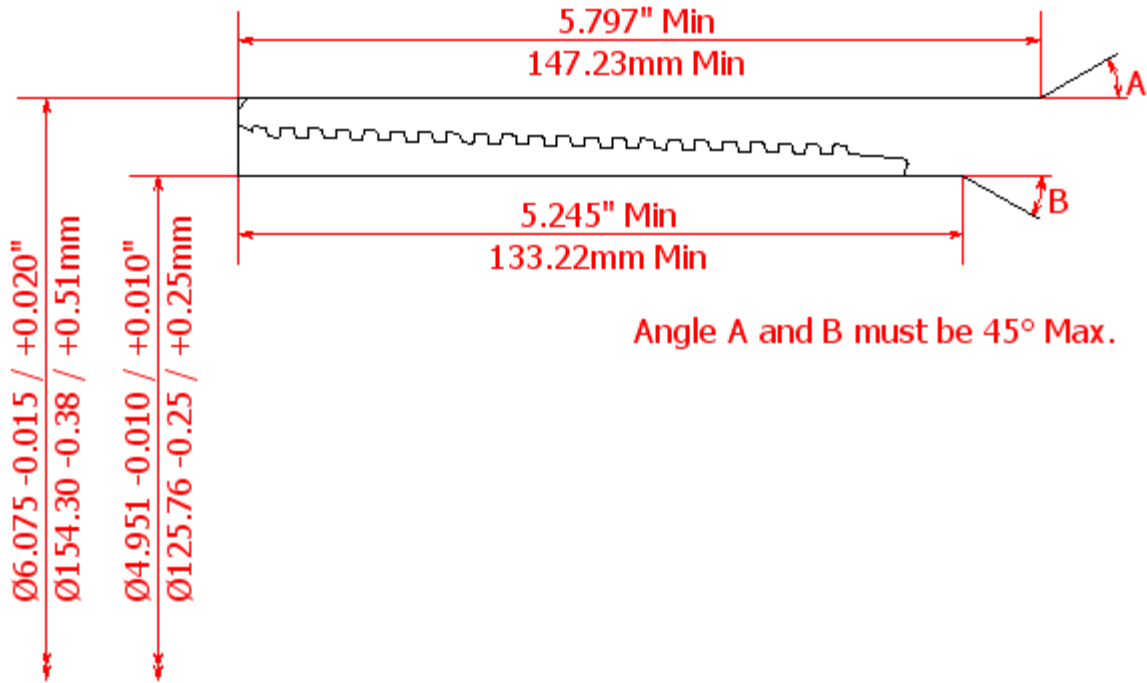

**HSC COUPLING (SPECIAL CLEARANCE OD)**

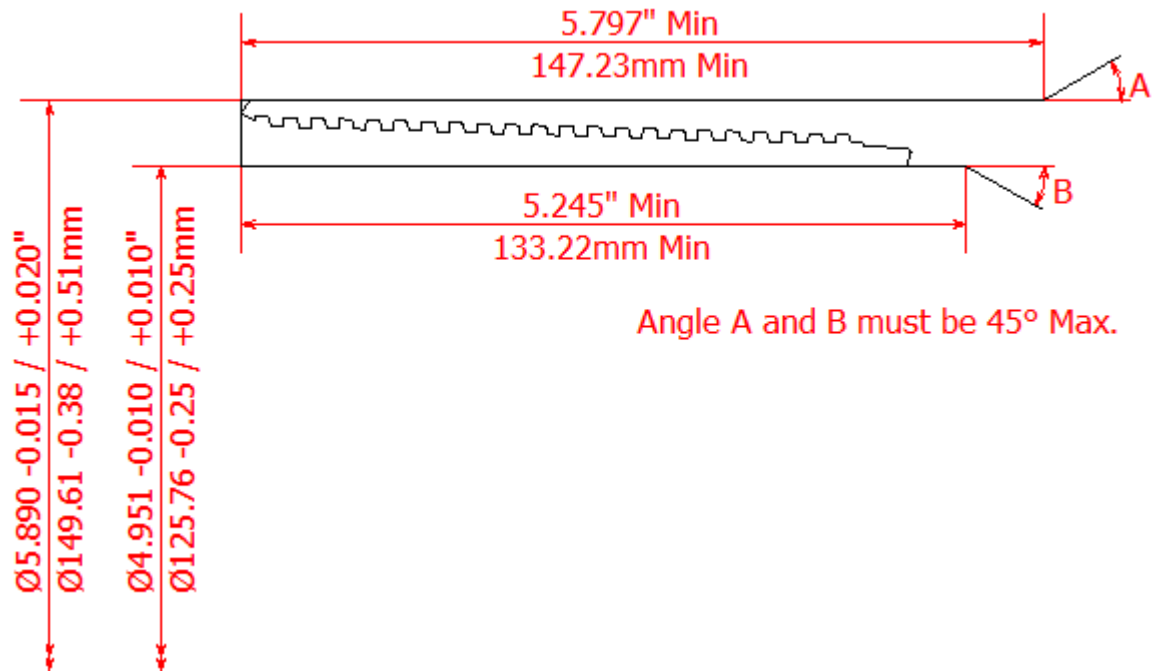

**HSC PIN**

