

BLANKING DIMENSIONS FOR 6 5/8" x 24lb/ft (168.28mm x 8.94mm WT)

HSC COUPLING (REGULAR OD)

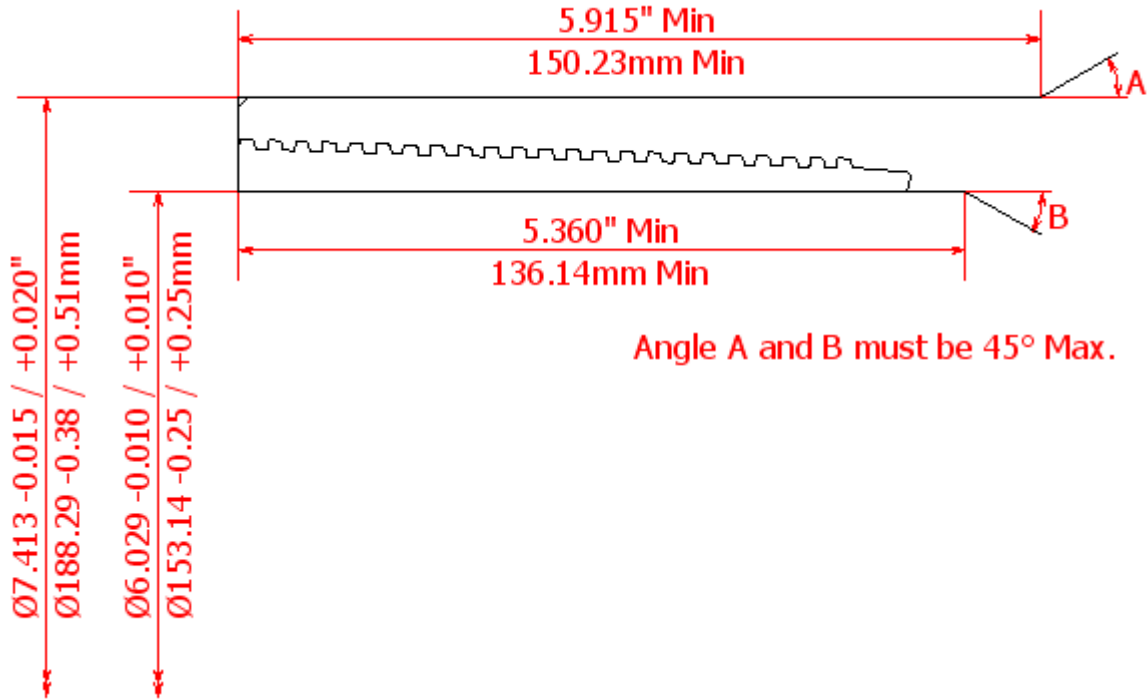

HSC COUPLING (SPECIAL CLEARANCE OD)

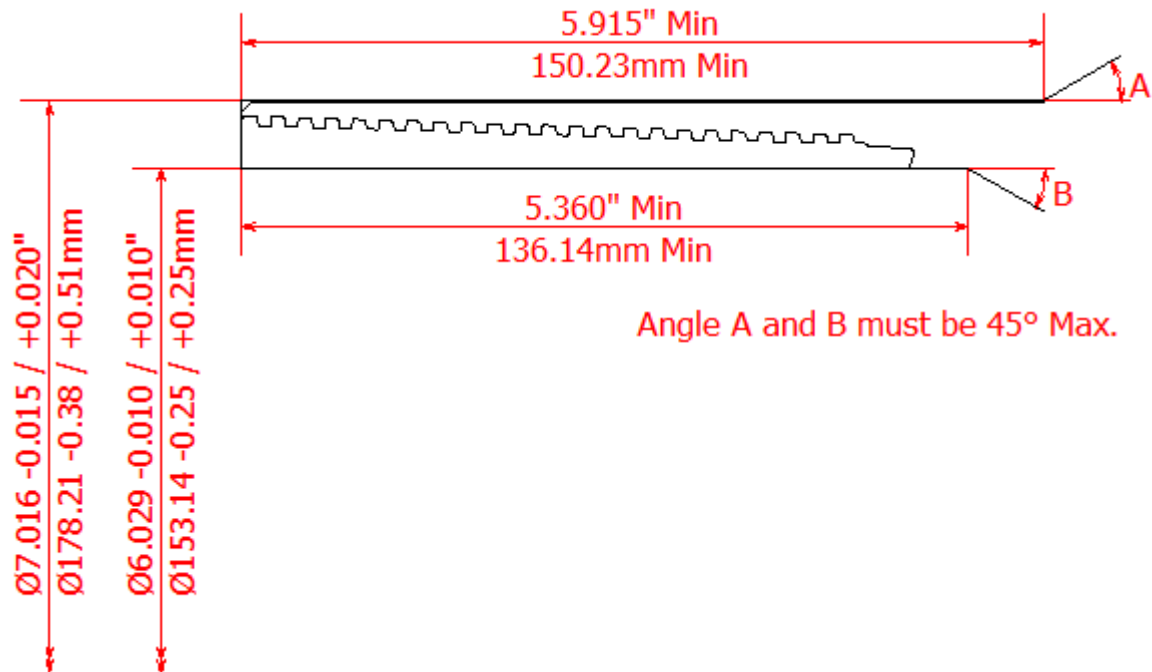

HSC PIN

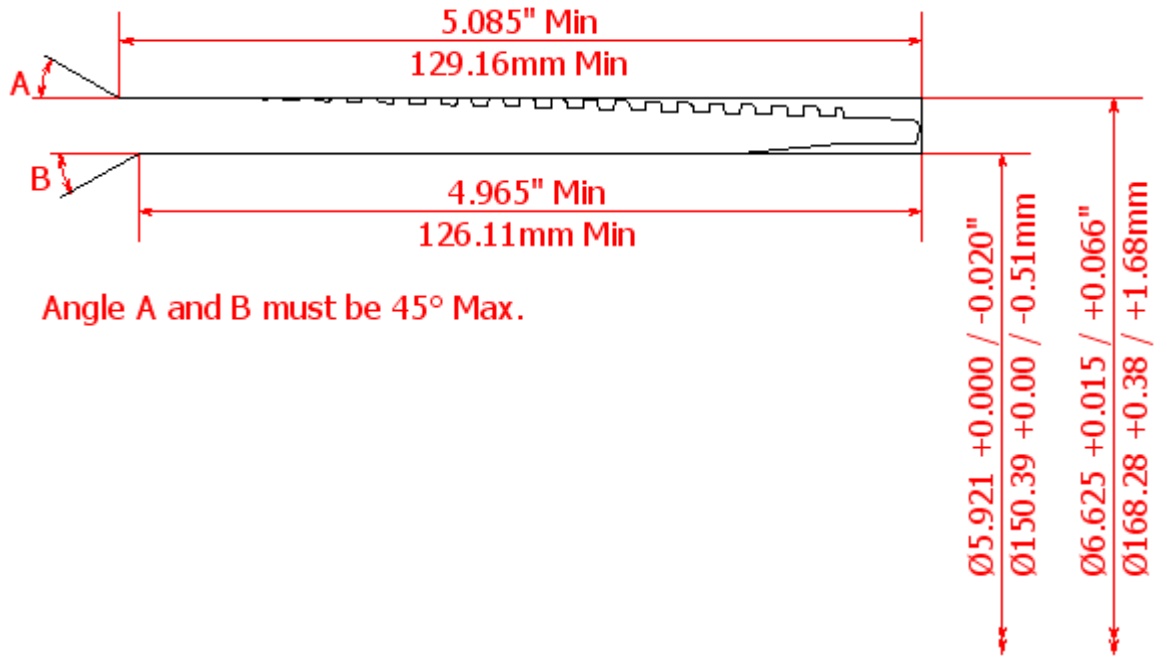

Angle A and B must be 45° Max.